

INSTRUCTIONS

MODEL MO 2890

FREQUENCY MONITOR

MODEL MO 2639

MODULATION MONITOR

I. B. 805

F. C. C. APPROVALS
MO 2890 MONITOR - 1469
MO 2639 MONITOR - 1556

COPYRIGHTED 1948

BY

GATES RADIO COMPANY

MANUFACTURING ENGINEERS SINCE 1922

QUINCY, ILL., U. S. A.



INSTRUCTIONS MODEL MO2890 FREQUENCY MONITOR

The Gates MO2890 Frequency Monitor for amplitude modulated radio broadcasting stations has been designed to meet all exacting requirements to visually indicate carrier frequency and will operate on any frequency between 540 and 1600 kilocycles. The crystal supplied has been prepared for the exact frequency of operation and is so stated on the serial number plate. The MO2890 frequency deviation monitor has been fully approved by the United States Federal Communications Commission and has been assigned approval number 1469.

The fundamental operation consists of a specially constructed crystal oscillator which beats against the broadcasting station frequency causing an audio beat of a still different frequency which is measured by a direct reading frequency meter. Size is 19 1/4" high and 13" deep.

DETAILED DESCRIPTION

General

The instrument consists of the following stages: crystal oscillator, one buffer stage, detector mixer, an audio amplifier, and a frequency indicating meter.

Oscillator

The oscillator stage consists of a crystal controlled oscillator in an extremely stable circuit employing a 6AC7/1852 tube. The crystal is mounted in a special type crystal holder, so designed that the crystal is held between six pins and will not shift frequency even in the presence of extremely heavy vibration. The oscillator, including its tube, is constructed on a small chassis which slides into the outer oven chamber and may be removed for service if necessary. The oscillator is designed to tune over the entire broadcast band, and the monitor may be recalibrated on a different frequency with a minimum of effort. A trimming condenser, C17, is provided with a screwdriver adjustment which may be reached from the back of the unit to center the frequency to that of an external standard.

Crystal Temperature Control

The temperature control system consists of a comparatively large aluminum block in which are inserted two cartridge type heaters controlled by means of a mercury column thermostat in a positive acting relay circuit. A bi-metallic thermostat is also provided as an emergency unit for further protection to the mercury thermostat and indicating thermometer. The heat differential of the crystal holds well within plus or minus 0.3 degrees centigrade.

This heater assembly is mounted in an oven constructed of one inch insulating board faced with 1/8" asbestos-cement flexboard. This complete oven is mounted within a second temperature controlled oven operating at an ambient temperature 5 to 6 degrees lower than the temperature of the crystal. The temperature of the outer oven is controlled by means of a rugged bi-metallic thermostat, and maintains the ambient temperature within plus or minus one degree centigrade.

Input Stages

On the rear of the main chassis is provided a coaxial connector, J2, for the sampling line from the transmitter. This line feeds to a 6H6 tube as a diode, which measures the amount of signal present, and then directly to the grid of a 6C5 triode used as a mixer tube. The standard oscillator circuit is fed through a 6SJ7 buffer stage to the second diode of the 6H6 tube, which measures the amount of standard oscillator signal present, and then to the grid of the mixer tube. As the oscillator stage is tuned 500 cycles below the carrier frequency an audible signal of 500 cycles is produced. A gain control is provided in each channel to adjust the two R.F. circuits to give the most satisfactory audio beat.

Audio System

The audio stage consists of a 6SJ7, pentode connected, feeding a 6V6 output tube. The output is fed to the frequency meter and is available at a jack on the front panel for audible checking. The output is measured with a voltmeter. A volume control is provided to maintain constant level on the frequency meter.

Frequency Deviation Meter

The frequency deviation meter is a direct reading meter with a center frequency of 500 cycles. The meter is calibrated for 30 cycle deviation high or low in one cycle steps.

POWER SUPPLY

The power supply is constructed on a separate chassis and provides the complete voltage supply plus the oven heating and control circuit. A 5U4G tube is employed as the power rectifier, an OD3/VR150 is used to supply regulated voltage to the oscillator tube and heat control tube, and a 6SH7 is used as a heat control tube for the inner oven.

INSTALLATION

Caution

It should be noted that the frequency monitor is a precision instrument, and although it is ruggedly built, it should be handled very carefully, and should receive as little abuse as possible if the extreme accuracy required of the instrument is to be maintained.

Packing

Included with the frequency monitor are the crystal holder, thermostat, and the right angle thermometer which are removed for shipping. A piece of 1/4" rod is enclosed for aligning the thermometer hole. The 5U4G tube is also removed for shipping.

Mounting

The monitor should be mounted in a substantial rack, preferably at some point in the room out of drafts, away from radiators and out of the direct rays of the sun. It has been found that the temperature varies little over wide ranges of room temperature. However, if subjected to abnormal heat the crystal temperature may assume a higher temperature than for what the instrument was calibrated. However, as long as the temperature remains consistent, and the center frequency is once set by the control provided, the accuracy of the instrument will be maintained. Care should be taken that the monitor be kept a reasonable distance from any unshielded high power RF circuits -- 5 or 6 feet should suffice in most instances.

Inserting Crystal Holder

An air gap type crystal holder is supplied. The air gap is carefully adjusted before shipping and should not be tampered with. Care should be exercised in handling the holder after removing from the packing. To reach the inner oven, remove the outer dust cover from the rear of the monitor, then remove the back of the outer oven by means of the two knurled screws on either side. The back of the inner oven is removed in the same manner. The crystal holder may then be slipped into the heat block socket.

Inserting Thermostat

The mercury column thermostat is removed for shipping. These thermostats are quite fragile and should be handled carefully. On unpacking, inspect the unit carefully and be sure that the mercury column has not separated in shipment. If the column has separated reform column as described in section entitled, "Care of Thermometer, etc." When the thermostat has been determined satisfactory, it is inserted in the hole in the top of the aluminum heat block in the inner oven. The two leads from the thermostat should be connected to the two terminals as shown on illustration A-3768. Be sure thermostat is located in hole behind "V" spring as shown on drawing.

The back of the inner oven should then be replaced. Before replacing the outer cover be sure that the oscillator unit with its tube is pushed back as far as it will go in its track. The outer end of the oscillator will be flush with the end of the track. Before replacing the dust cover make the RF connection to jack J2.

DRAWING NUMBER
A-2991

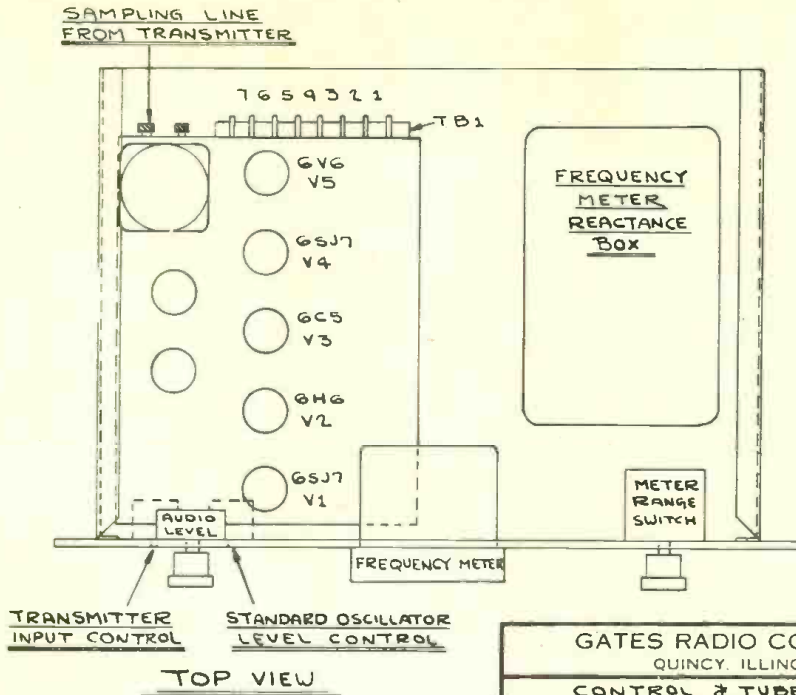

GATES RADIO COMPANY QUINCY, ILLINOIS		
CONTROL & TUBE LAYOUT FREQUENCY MONITOR MO-2890		
MATERIAL	SCALE	3/8
DR. BY R.E.K.	DATE 1-27-48	DRAWING NUMBER
CH. BY L.P.E.	ENG. L.P.E.	A-2991

DRAWING NUMBER
A-3768

NOTE
TO INSERT THERMOSTAT
PULL BLOCK FORWARD
AFTER DISCONNECTING
LEADS AND LAYING
THEM FLAT

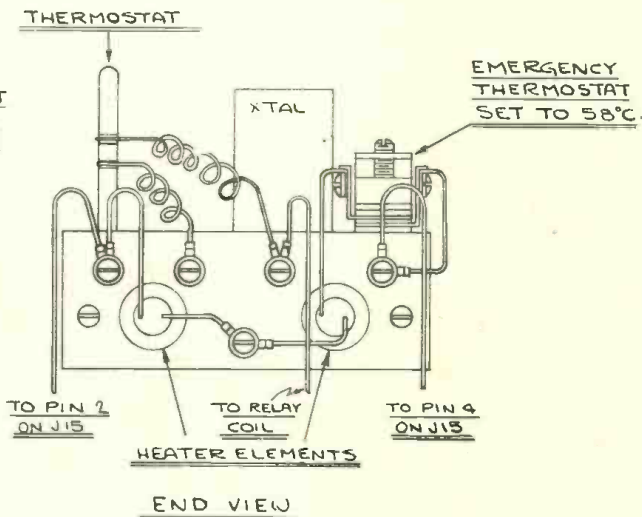

CAUTION:
KEEP THE THERMOSTAT
TOWARD CENTER OF BLOCK
AS SHOWN.

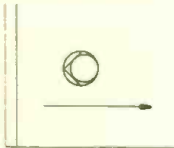

GATES RADIO COMPANY QUINCY, ILLINOIS		
TERMINAL CONNECTIONS ON FREQUENCY MONITOR HEAT BLOCK		
MATERIAL	SCALE	FULL
DR. BY R.E.K.	DATE 10-29-47	DRAWING NUMBER
CH. BY L.P.E.	ENG. L.P.E.	A-3768

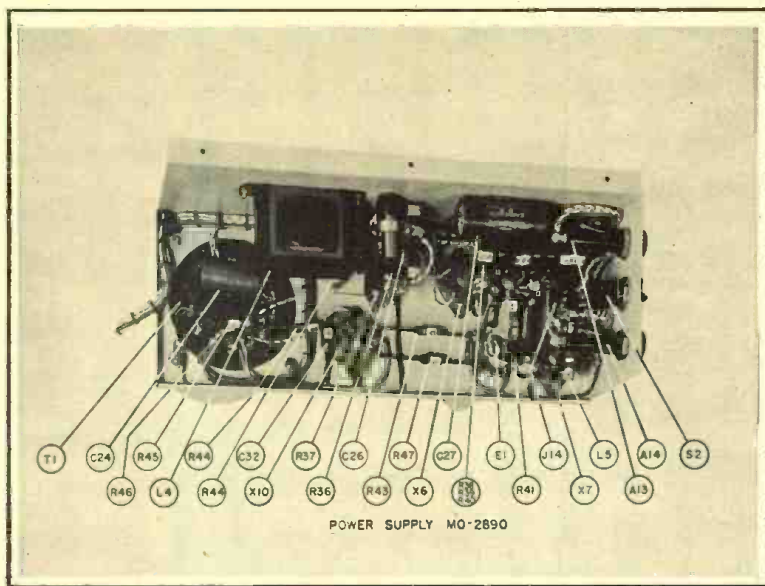

Fig. 3 - Power Supply MO 2890 Monitor

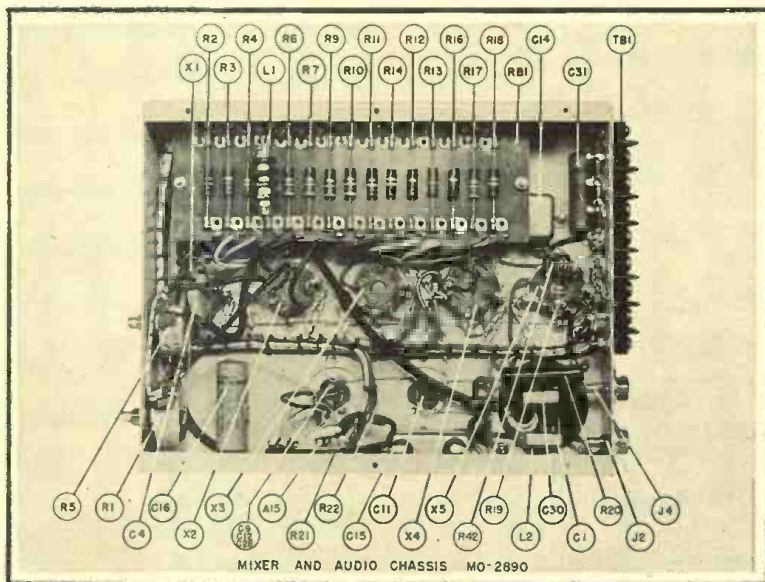

Fig. 4 - Mixer and Audio Chassis MO2890

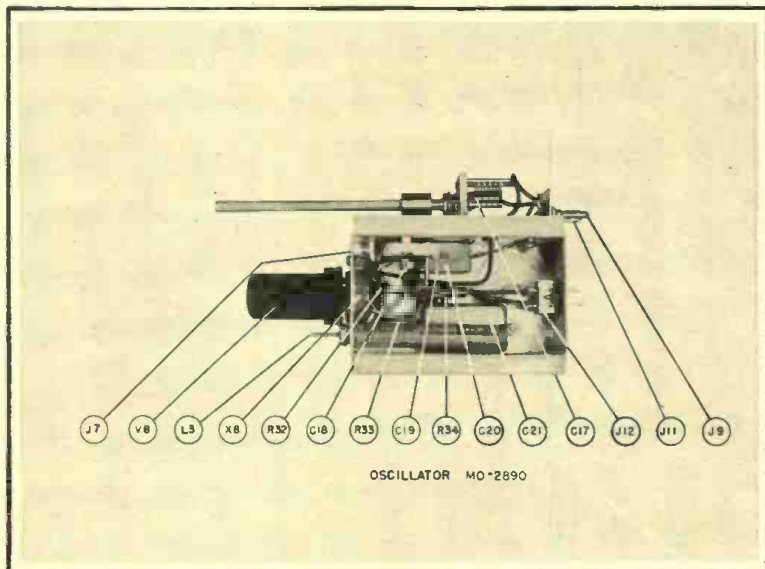

Fig. 5 - Oscillator MO2890

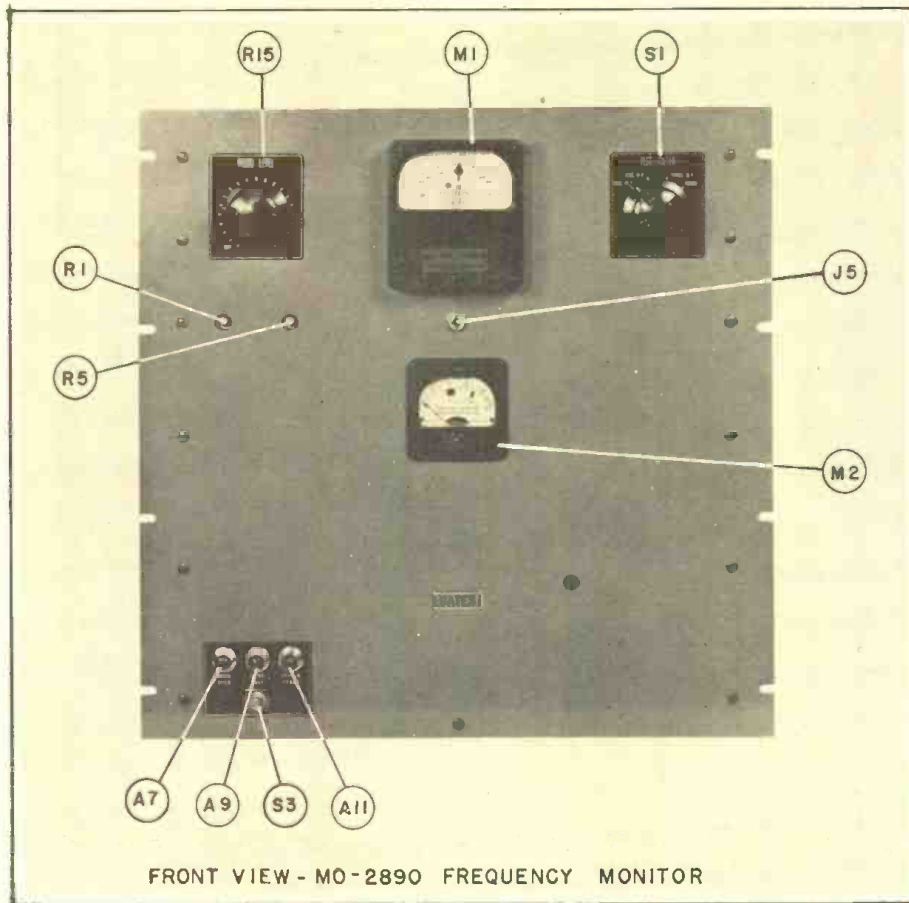

Fig. 1

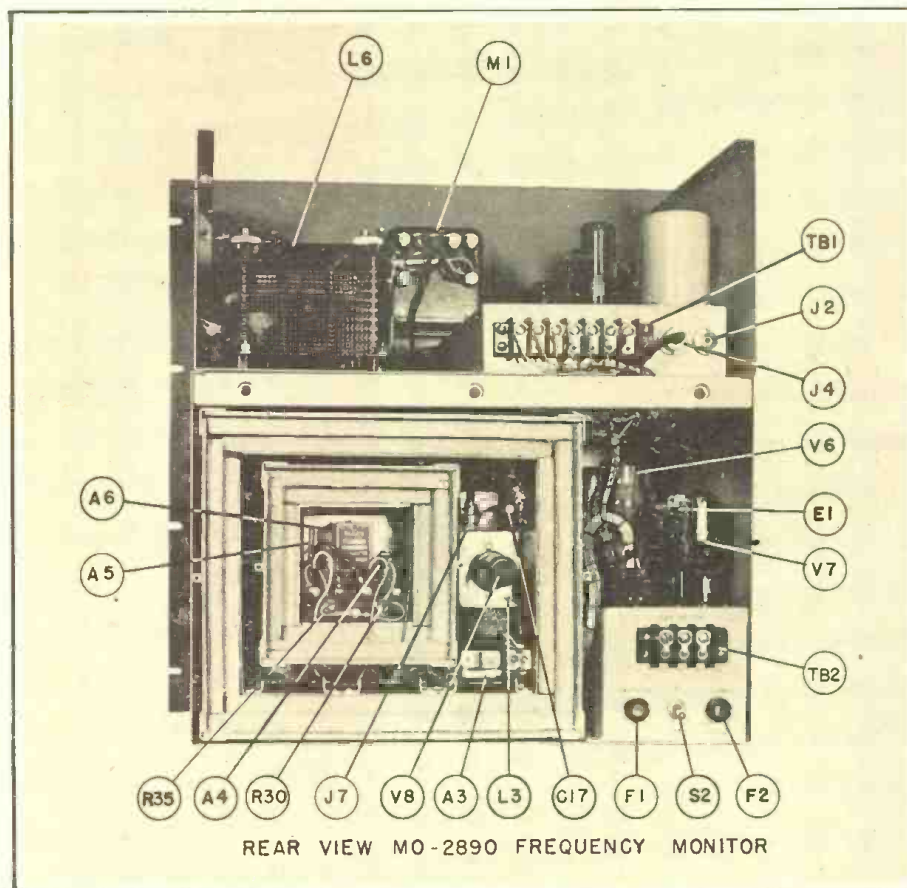

Fig. 2

S1	A-3749-1	Meter range switch
TB1		Terminal Board, H.B. Jones 7-142Y
V1		Tube, 6SJ7
V2		Tube, 6H6
V3		Tube, 6C5
V4		Tube, 6SJ7
V5		Tube, 6V6
X1		Socket, Octal, Amphenol MIP8T
X2		Same as X1
X3		Same as X1
X4		Same as X1
X5		Same as X1
		Heat Chamber Dwg. No. (A-3776-101)
A3		Bi-metallic thermostat, Geo. Ulanet Co. ASK-SB-300NC
A4		Same as A3 Part of A-4033-101
A5		Mercury Column Thermostat A-6948, GL-100-V35, AICO
A6		Crystal and Holder, Bliley Type AR3, Specify frequency to be 500 cycles (0.5 KC) less than transmitter frequency. 1 cycle/megacycle/°Cent. (Order from MO Sheet on customer order)
C29		Capacitor .1 mfd., @ 600 V DYR-6010 C-D
J3		Coaxial plug, Jones P-101-1/4
J6		Same as J3
J8		Banana Plug Connector, Johnson #74
J10		Banana Plug Connector, Same as J8
J13		Connector Plug, Jones S-304-AB
J15		Connector Plug, Jones P-310-FHT
J18		Banana Plug, Johnson #75C
J19		Same as J8 Part of A-4033-101
J20	A-3577-1	Banana Plug Connector Part of A-4033-101
J21		Same as J18
R23	A-3871-1	Resistor 75 ohm 10 W. Wirewound (Special)
R24	A-3871-1	Same as R23
R25	A-3871-1	Same as R23
R26	A-3871-1	Same as R23
R27	A-3871-1	Same as R23
R28	A-3871-1	Same as R23
R29		Resistor 47 ohms, 2 W. 10% Carbon
R30	A-4373	Heater 150 W. 115 V.
R31	A-4373	Same as R30 Part of A-4033-101
X9		Socket, Amphenol MIP5-T Part of A-4033-101

C7		Same as C2
C8		Same as C2
C9		Capacitor 20 mfd., @ 25 V, section of C-D, UP-4C-J43 20-20-20 mfd., @ 25 V.
C10		Capacitor .1 mfd., @ 600 V. C-D DYR-6010
C11		Capacitor 10 mfd., @ 450 V. C-D UP-4A-J57
C12		Section of C9
C14		Same as C10
C15		Same as C10
C16		Capacitor .25 mfd., 400 V.
C28		Section of C9
C30		Same as C1
C31		Capacitor .1 mfd., 400 V. C-D Tiger
J1		Coaxial Plug, H.B. Jones P-101-1/4
J2		Coaxial Connector, H.B. Jones S-101
J4		Same as J2
J5		Phone Jack, Carter 2-A
J17		Power Plug, H.B. Jones P-306-FHT
L1		R.F. Choke, Miller #4537
L2	A-3121-1	Audio Choke
L6		Frequency meter reactance box, supplied with frequency meter
M1		Frequency Meter, Weston Model 610 Calibrated for 500 cycles
M2	A-4011-1	Meter, Weston Model 301 Square 0-100 Micro Ammeter, Special Scale
R1	A-3404-2	Resistor, 50,000 ohms, Potentiometer Curve 6, 3/4" shaft
R2		Resistor, 100 K ohms, 1 W. 10% Carbon
R3		Resistor, 1200 ohms, 1 W. 10% Carbon
R4		Resistor, 27,000 ohms 1 W. 10% Carbon
R5	A-3404-2	Same as R1
R6		Resistor, 47,000 ohms 1 W. 10% Carbon
R7		Resistor, 47,000 ohms 1 W. 10% Carbon
R8		Shunt, 10 milliamperes spool shunt for Weston 301-0-100 microamp.
R9		Resistor, 47,000 ohm, 1 W. 10% Carbon
R10		Same as R9
R11		Resistor 270,000 ohm, 1 W. 10% Carbon
R12		Same as R3
R13		Same as R4
R14		100,000 ohm 1 W. 10%
R15	A-3404-3	Resistor, variable 500,000 ohm, Curve 6 3/4" Shaft
R16		Resistor, 1500 ohm, 1 W. Carbon 10%
R17		Resistor, 470,000 ohm 1 W. Carbon 10%
R18		Same as R2
R19		Same as R17
R20		Resistor, 350 ohm 10 W. Wirewound
R21		Resistor, 680,000 ohm, 1 W. 10% Carbon
R22		Same as R9
R42		47 K ohms, 1 W. 10% A-B

J14		Connector S-310-AB Howard Jones
J16		Connector S-306-AB Howard Jones
L4		Filter Choke, R18 UTC
L5		R.F. Choke, #4537 Miller
R47		7500 ohms 1 W. 5% A-B
R35		Resistor 150 ohm, 1 W. 10% Carbon
R36		Resistor 250 ohm, 25 W. Adjustable Wirewound
R37		Resistor 125 ohm, 25 W. Wirewound
R38	A-2088-1	Resistor 170 ohm, (Part of 21170 ohm, 40 watt resistor)
R39		Resistor 3000 ohm, Part of R38
R40		Resistor 18,000 ohms, Part of R38
R41		Resistor 5000 ohms, 10 W. Lectrohms, 1-3/4 E.
R43		15 K ohms 1 W. 10% A-B
R44		1 megohm 1 W. 10% A-B
R45		390 ohms 1 W. 10% A-B
R46		390 ohms 1 W. 10% A-B
S2		Switch, ^{DPST} SPST , Bat Handle Toggle switch ^{8370-K7} 8280-K16 C-H
S3A		Switch, DPST, Bat Handle Toggle switch 8370-K7 C-H
S3B		Part of S3A
T1	AP-3065	Transformer, Power
TB2		Terminal Block, 3-142Y H.B. Jones
V6		Tube, Rectifier, 5U4G
V7		Tube, Voltage regulator OD3/VR150
V9		6SH7 Tube
X6		Tube Socket, octal MIP8T Amphenol
X7		Tube Socket, octal MIP8T Amphenol
X10		MIP8T Socket, Amphenol

Mixer and Audio Chassis
Dwg. No. (A-3775-101)

A1		Pilot lamp, Mazda #47 (Furnished with meter)
A2		Same as A1
A15		Meter Rectifier, CX2E4F Bradley Laboratories
C1		Capacitor .002 Type C Mica Sangamo
C2		Capacitor .01 Type J Mica Sangamo
C3		Same as C2
C4		Same as C1
C5		Same as C1
C6		Same as C1

<u>Symbol No.</u>	<u>Drawing No.</u>	<u>Description</u>
C17		Variable Capacitor, 15 mmf., Hammarlund HF15-X
C18		Variable Capacitor, 15 mmf., Hammarlund APC-15 (or equivalent)
C19		Capacitor .01 mfd., 300 D.C.W.V. Sangamo J-06110
C20		Same as C19
C21		Capacitor 0.1 mfd., 600 V. C-D DYR-6010
C22		Capacitor .00001 mfd., 500 D.C.W.V. Sangamo K-1410
J7		Connector Coaxial Jones #S-101
J9		Banana Plug E.F. Johnson Cat #75
J11		Same as J9
J12		Plug Connector, Jones P-304-AB
L3	(FE-101-N12) A-6210-101	Tank Coil and Slug Assembly
R32		Resistor 33,000 ohms, 1 W. 10% Carbon
R33		Resistor 300 ohms, 1 W. 5% Carbon
R34		Resistor 47,000 ohms 1 W. 10% Carbon
V8		Tube Oscillator 6AC7
X8		Socket, Octal, MIP8T Amphenol
Power Supply Dwg. No. (A-3595-101)		
A7		Pilot light socket, Dialco 810-BS (Min Bay) Smooth Red Jewel, Sand Blast
A8		Pilot Light Lamp, Mazda #47
A9		Same as A7
A10		Same as A8
A11		Same as A7
A12		Same as A8
A13		Fuseholder, Littlefuse #1075-S(341001)
A14		Same as A13
C24		Capacitor 50 mfd., 50 V. Mallory TC39 Only
C25		Capacitor 4 mfd., @ 600 V. TLA-6040 C-D or equivalent
C26		Same as C25
C27		16 mfd., @ 450 V. Tubular electrolytic CD-BR-1645
C32		Capacitor 0.1 mfd., 200 V. Aerovox Aerolite, P82
E1		Relay Clare type A-11488
F1		Fuse 3 amp. 3 AG
F2		Fuse 1 amp. 3 AG

(b) With the station's carrier standing at exactly the assigned frequency and being observed on the MO-2890 monitor as previously set out, some deviation from zero will likely appear. At the exact time that the frequency is being measured by the external source, the "Frequency Adjust" control on the oscillator heat chamber rear should be adjusted so that the monitor readings exactly concur with those indicated by the external measuring source.

When the monitor is shipped all adjustments are left exactly as set on the final test bench. When the monitor is placed in operation the only adjustment necessary should be the frequency adjusting capacitor in the heat chamber, reached through the hole stenciled "Frequency Adjust". Care has been taken that the screwdriver slot will be very close to vertical when on exact frequency. The oscillator should be tuned to 500 cycles below assigned frequency. It may be noted that the pointer on the frequency meter will not rest at zero when the instrument is turned off. This is normal in the construction of the meter.

WARNING: The frequency monitor covered by these instructions has been carefully adjusted against a frequency standard for sufficient time to assure no further adjustment will be necessary except the frequency adjusting capacitor. The customer is therefore warned not to make any other adjustments without first allowing the instrument to stabilize for at least 48 hours, and secondly to correspond with the Gates Radio Company describing exact behavior of instrument.

MAINTENANCE

Drawing A-2991 shows the tube layout and indicates the location of the adjustable resistors as shown on the schematic diagram. Should the instrument fail to operate, the tubes should first be checked. If all are found to be satisfactory, and a major repair is indicated, the instrument should be returned to the manufacturer for repair and recalibration. **DO NOT RETURN WITHOUT WRITTEN PERMISSION.**

If the crystal oscillator should fail to oscillate, usual service precautions should be observed. Snapping the switch on the rear of the power supply on and off may be sufficient disturbance to start the crystal oscillating. The instrument should be checked against the external frequency checking service at regular intervals to ascertain that it remains in accurate calibration.

The only contacts which might require burnishing are on the bi-metallic thermostat located in the lower right hand corner of the outer oven and the relay on the power supply chassis. Be sure to turn off the AC power switch before attempting to clean these.

WARRANTY

For guarantee on the MO2890 frequency monitor see page entitled "Guarantee" in the back of this book. Do not return merchandise to the factory without written permission, as this will save you time and expense.

Changing Frequency

On page one under the heading "Oscillator" it is stated that the MO2890 monitor may be recalibrated on a different frequency with a minimum of effort. However, due to FCC approval and likewise the need for a frequency standard in effecting the recalibration, it is necessary in all instances where the equipment is under the jurisdiction of the FCC that the frequency monitor be recalibrated at the Gates factory and a new serial number be assigned for the recalibrated frequency. Users of the Gates MO2890 monitor should request permission to return the equipment to the factory for recalibration at which time a quotation for the cost for so doing will be submitted along with shipping information. Monitors returned should be returned in the same type of packing container and with the same items removed as for original shipment. As this instruction book defines the items that have been removed no difficulty will be experienced.

After the instrument is once turned on this switch should not be shut off except when necessary to work on the monitor making necessary repairs or adjustments.

The inner oven thermostat (A5) is adjusted to approximately 56° centigrade. When this thermostat heats up from a cold start it may be found to be slightly erratic. However, after a few heat cycles it will settle down and control the temperature within plus or minus 0.3° centigrade continuously. A second thermostat (A4) of the bi-metallic type is placed in the inner chamber for emergency protection. This thermostat is adjusted for 58° centigrade or the top calibration on the thermometer. If the temperature goes to 58° it would indicate that the mercury thermostat is not operating. By shorting out the two terminals of the thermostat the relay should operate. Check the connections and finally check the thermostat itself for a break in the mercury column and rejoin as described under "Care of Thermometer." Adjustment of the bi-metallic thermostat is permanent and should not be changed in the field. The temperature of the outer oven may be checked by means of a straight laboratory type thermometer inserted through the hole on the rear of the oven stenciled "thermometer". This temperature should be approximately 50° centigrade, and will maintain plus or minus 1° centigrade. If it should be necessary to adjust the outer oven temperature, the thermostat (A3) is available through a second hole on the back of the oven stenciled "thermostat" which may be turned by means of a slim screwdriver. Clockwise rotation of the screw will result in an increase in temperature.

A laboratory type thermometer calibrated in degrees centigrade with a range of -10° C to +110° C may be purchased from the Gates Company at a nominal price for checking the outer oven temperature.

After the ovens have started to heat, turn the audio level control (R15) to minimum (counter-clockwise) and turn on the monitor switch (S3) on the front panel which will illuminate the meter dial and place the upper chassis in operation. Turning the meter range switch (S1) to "Oscillator Plate" will show the plate current of the oscillator tube. This reading will be approximately 7 Ma. (+ 20%) when the oscillator is operating properly.

Turn meter switch to "Osc. R.F." and measure the oscillator voltage present at the grid of the mixer tube by means of meter M2. Proper voltage should be in the black block on the meter scale marked "R.F. Level". This voltage may be adjusted if need be by removing plug button R5 to allow adjustment of control R5 with a small screwdriver. Now turn meter range switch to "Trans. R.F." and adjust R1 to the black block on meter M2. R1 is reached by removing plug button R1 on the front panel. Failure to energize the meter to the blocked portion indicates insufficient drive and more excitation from the transmitter is required. Now turn the meter switch to "Audio level" and by adjusting the audio level control bring the meter to the block marked "Audio level" on M2. Inserting headphones in the jack between the two meters should give an audible tone of approximately 500 cycles. The frequency meter is now in operation and should read close to zero if the adjustment on the rear of the unit has not been touched.

IMPORTANT: The input circuit on the R.F. rectifier is untuned and will respond to radio frequency energy of any frequency. It is possible, therefore, to accept and meter harmonics of the fundamental radio frequency carrier wave of the broadcast transmitter being monitored.

If, after initial setup and check against outside frequency standard, it is found that D.C. carrier indications are reading on the supervisory meter, yet it is impossible to secure sufficient audio frequency level on the frequency indicating meter, it is highly probable that a harmonic is being indicated on the "Transmitter" meter position. This condition would be extremely rare.

If the deviation meter shows considerable deviation, the plug button should be removed from the hole on the rear of the outer oven stenciled "Frequency Adjust". This control (C17) should be turned until the deviation meter comes to zero. It will require approximately four hours for the crystal temperature to raise to its operating level. However, it would be well to allow the monitor to heat at least 48 hours before making final exact adjustments.

(a) After the 48 hour initial heat cycle has been passed, the radio frequency carrier of the broadcast station being monitored should be checked with an external frequency measuring source of unquestionable accuracy and the carrier adjusted to exactly zero beat on the assigned channel frequency.

CARE OF THERMOMETERS AND THERMOSTATS

The mercury column thermometer and thermostat used in the frequency monitor are precision devices. They may be relied upon to give accurate results when installed in the monitor. However, being constructed of glass they are extremely fragile and should be handled accordingly. It has been found that due to vibration and shocks of shipping that the mercury column may separate. To rejoin the column first hold the bulb over a heat source such as a soldering iron or open lamp bulb and carefully drive the mercury up into the capillary. Then remove from the heat and cool rapidly which will draw the mercury back into the bulb. After room temperature is reached it may be further reduced by placing the bulb in ice water which will draw all of the mercury out of the capillary and into the bulb. A few judicious taps should remove any further separation. Apply again to the heat and run the mercury up to the operating range of the thermometer and inspect the column for breaks. In extremely stubborn cases it may be necessary to procure a little dry ice in order to draw all of the mercury into the bulb. When heating the thermostat drive the mercury up into the well above the capillary. If any mercury remains in the capillary above the well it can be shaken down into the well where it will rejoin the main column. CAUTION: The maximum temperature which these devices will handle is about 60° C. or 140° F. Do not apply directly to heat sources. If after a reasonable effort you cannot correct the fault, obtain a replacement unit. Broken units cannot be accepted, therefore, handle them carefully and pack well.

Inserting Thermometer

Due to its fragility, the thermometer must be removed for shipping, and care should be taken on its insertion into the instrument. By removing the two small screws on the bakelite mask on the front panel, the hole is revealed through which the thermometer is to be inserted. Inasmuch as the thermometer stem must pass through two thicknesses of insulation and into the crystal heat block, it is essential that this hole be carefully aligned before inserting the stem. A piece of 1/4" rod is furnished with the instrument to facilitate in aligning the hole. Be sure that the rod goes to the full depth of the thermometer stem easily before attempting to insert the thermometer. When the instrument was aligned at the factory the thermometer was very free in the hole, therefore, any tendency to bind should be eliminated by means of the rod. In tightening the bakelite mask over the thermometer, care should be taken that no binding occurs, and tighten the screws so they are just snug.

CAUTION: If for any reason it is necessary to move the monitor, remove the thermometer before removing from the rack and do not reinsert until the monitor is in its final position.

Transmitter Connection

Connection of the MO2890 Frequency Monitor to the transmitter should be to an unmodulated stage in every instance. Most makes of transmitters have prepared connecting points for the frequency monitor but where this does not exist a pickup coil of 5 turns of wire on a 4 inch form will do nicely or more turns on a smaller diameter form if desired. The power absorbed is negligible. Connection to the monitor should be made with low loss cable such as RG8U or open dielectric cable. Use jack J2 to connect to the monitor input which it will be noted has been prepared for RU type cable.

Power Connection

The 115 volt 60 cycle power connection is made to terminal block TB2.

Replacing Dust Cover

Before replacing dust cover be sure all tubes are pushed down tight in the sockets and the two plugs near the back of the power supply are in place. The lock buttons on the dust cover require about a half turn to lock.

OPERATION

After the installation has been completed, the power may be turned on by means of the switch S2 on the rear of the power supply. This switch controls the oven heating circuits as well as the filament voltages on all of the tubes and the oscillator voltage and the oscillator plate supply.

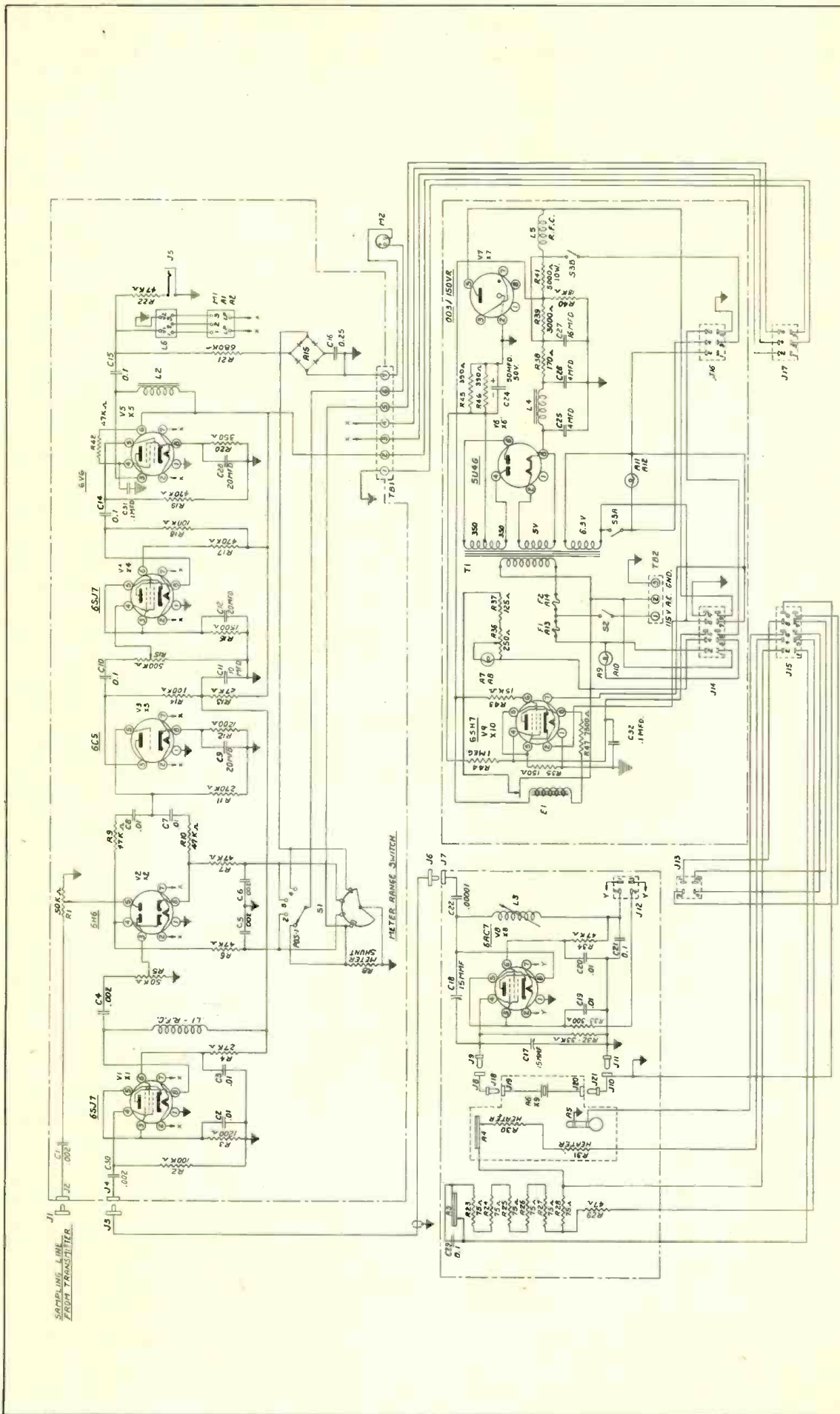

GATES RADIO CO. QUINCY, ILL.	
OVERALL SCHEMATIC FOR FREQUENCY MONITOR MD-2690	
DR BY: M.A.Y.	DATE: 10/15/47
CHK BY: J.P.E.	ENC. L.P.E. D-20235
1	REVISED
2	REVISED
3	REVISED
4	REVISED
5	REVISED
6	REVISED
7	REVISED
8	REVISED
9	REVISED
10	REVISED
11	REVISED
12	REVISED

INSTRUCTIONS FOR GATES MODEL MO2639 MODULATION MONITOR

The Gates MO2639 Modulation Monitor is designed to read percentage of modulation and carrier shift of AM broadcast transmitters operating between 200 Kc and 5000 Kc.

Carrier shift, either positive or negative, is read on the lower meter. This meter is also used to indicate the carrier level. Modulation percentage readings are independent of frequency as the response is flat within 1/2 Db over the 30-10,000 cycle range. The accuracy is $\pm 2\%$ at 100% modulation or $\pm 4\%$ at any other percentage of modulation.

The meter damping and speed is such that peaks of modulation of duration between 40-90 milliseconds are indicated to 90 percent of full value and the discharge rate timed so that the pointer returns from full reading to 10 percent of zero between 500 and 800 milliseconds.

A polarity switch is provided so that either positive or negative peaks may be read with the center position connected so that there will be no readings on the percentage of modulation meter but still allow readings on the carrier level meter.

A peak indicating flasher is provided to indicate negative peaks between 50 and 100 percent or positive peaks between 50 and 120 percent. In conjunction with the peak flasher is a relay which may be used to operate a peak counter or alarm device.

A peak level control is provided so that any chosen level between 50 and 120 percent modulation will cause the flasher and relay to operate.

Note that the flasher circuit does not have the same high degree of accuracy as the modulation meter since it is, to an extent, dependent on the AC input line voltage. It does, however, indicate more accurately than the meter on fast staccato peaks of very short duration since there is a certain amount of unavoidable inertia in the meter movement.

A two stage audio amplifier is incorporated to provide two watts of audio power for connecting directly to an 8 ohm loudspeaker. The gain control on the lower left hand side of the front panel controls the output of this amplifier. This output should not be used for FCC proof of performance tests.

On terminals 7 and 8 is an external jumper. A remote external modulation meter may be connected in place of this jumper. Where this is desired it may be ordered from the Gates factory as type A1363.

INSTALLATION

Provisions are made for standard rack mounting. Installation should not be made where the modulation monitor will be subject to strong RF or magnetic fields. A good electrical ground is mandatory if leakage currents are to be avoided.

A power supply source of 115 volts, 60 cycles is required. Variations of $\pm 5\%$ will have no effect on the accuracy of the meter readings. Line variations of $\pm 15\%$ usually cause less than 4% variations. A power supply source, which is subject to rapid voltage variations, however, should be avoided. Power consumption at the rated voltage is approximately 110 watts.

Several methods of coupling the modulation monitor to the transmitter are shown in Drawing B-10830. Methods 1, 2, and 3 are perhaps the most convenient. However, with these methods any harmonics in the plate tank circuit of the transmitter or the transmission line are passed on into the modulation monitor, possibly introducing errors in the percentage modulation indication. This may also show up as a difference in the "Carrier Set" level when the modulation monitor polarity switch is turned from positive to negative.

When this condition occurs the monitor coupling loop should be de-coupled as much as possible while still permitting maintenance of the "Carrier Set" level at the 100 point. In other words, decrease the coupling of the monitor pickup loop and increase the "Carrier Set" control to near maximum.

Methods 4, 5 and 6 discriminate against harmonics and are to be preferred. Since the modulation monitor has high impedance input these fill the impedance requirement while simultaneously allowing "looser" coupling of the pickup loop to the transmitter. In using method 4, coil L1 and C1 should resonate at the operating frequency. Where RG8/U coaxial cable is used allowance must be made for the internal capacity of the cable. This capacity is 29.5 mmfd per foot.

Method 5 is essentially the same as 4 except the greater portion (L2) of the coil has been moved to the other end of the modulation monitor coaxial cable and the few remaining turns now serve as the link pickup.

Method 6 is a further evolution of method 5. As is readily evident, it is a simple link coupling to a resonant tank. Of all methods, this is probably the best all around method of the six shown. The transmission line may be RG8/U coaxial cable instead of the twisted pair shown. The capacity of the cable has little effect as long as the tap on L2 does not exceed one-fourth the total number of turns.

The audio output, external alarm, and external meter leads should all be shielded cables to prevent undesirable RF and magnetic field induced currents. Terminals 3 and 4 are for connection directly to a 6 or 8 ohm speaker field. A mismatch will result in a loss of power transfer and should be avoided.

ADJUSTMENT

A check should be made once a month to maintain the accuracy of the monitor. An oscilloscope will be required to make this check or adjustment. After the equipment has been permitted to warm up for a 30 minute period, the "carrier set" control should be advanced until the carrier level meter reads 100 or mid-scale. (The RF pickup loop should be adjusted so that with normal power variations and/or nighttime reductions in power the "carrier set" control will bring the meter pointer back to the mid-scale point).

With the carrier level meter reading 100, modulation should slowly be applied to the transmitter until 100% modulation is obtained as ascertained by the oscilloscope. (The pos-neg control should be in the neg position for this adjustment). If the modulation meter does not read 100%, R1 should be turned until the 100% point is reached. (R1 is the screwdriver adjustment on the top of the chassis next to the front panel. After adjustment it should be re-locked). If the modulation meter will not zero with no modulation applied to the transmitter it may be necessary to either adjust R15 or replace V2, V3, or V4. If this adjustment is made the adjustment of R1 should be rechecked.

If the carrier level meter moves from the mid-scale point with 100% modulation it should not be readjusted as this indicates carrier shift or a change in operating power. By switching off the modulation it may be ascertained which of the two has taken place.

The flasher and alarm circuit may now be adjusted. With 100% modulation applied the "modulation peaks" control should be set to 100%. By means of R6 the flasher is caused to start flashing. (R6 is located on the top of the chassis next to the relay). Care should be taken in setting this control as a slight turn in R6 makes several degrees difference in the setting of the "modulation peaks" control. Now the 50% modulation point should be checked. The transmitter should be modulated 50% as ascertained by the "modulation percentage" meter. When the "modulation peaks" control is turned to the 50% mark it should cause the flasher and alarm relay to operate. If difficulty is had in getting the pointer to coincide with the 50% mark, the knob may be loosened and rotated a few degrees. It will be necessary to readjust R6 at the 100% mark. Usually no more than a 20 degree rotation of the "modulation peaks" control knob on its shaft is required to obtain correct calibration.

C3 is a variable capacitor used to balance out the effects of the wiring capacity and the internal capacity of V1. This is set at the factory and normally does not require adjustment in the field. Need for adjustment is indicated when throwing the polarity switch from Pos to Neg causes a change in the carrier level meter reading (transmitter unmodulated). It should be turned until the meter reads the same on both positions of the switch. This should not be confused with the conditions caused by incorrect coupling as outlined in paragraph 3 of the installation section. Experience has shown that coupling is practically always the real cause of this condition. R26 and R11 are set at the factory and should not be changed in the field as the accuracy of the modulation monitor with line voltage changes is dependent on these two pre-set values.

OPERATION

Daily operation requires only occasionally checking the carrier level to keep it at the mid-scale point.

If power is reduced the carrier set control should be advanced until the meter pointer again reads 100 or mid-scale.

MAINTENANCE

A monthly check should be made against an oscilloscope to prevent any inaccuracies due to aging

of tubes, etc. To obtain the greatest accuracy in checking and calibrating it should be borne in mind that the largest and sharpest oscilloscope pattern gives the most accurate results. The relay contacts are easily accessible and should be cleaned periodically to insure proper operation of external counter or alarm. Tubes should be checked monthly along with and before checking the calibration of either the "percentage of modulation meter" or "modulation peaks" control setting. CAUTION: The accuracy of the flasher and alarm circuit is less than that of the "percentage of modulation meter". The flasher should always be checked when making the check on the "percentage of modulation meter".

Should it be necessary to replace tubes V3 and V4, R1 should be readjusted in order to maintain the 2% accuracy of the instrument. This inaccuracy shows up at the low end of the meter scale and in practice is not consequential. To maintain the original factory accuracy the following procedure may be used:

1 - Short the two top meter terminals of M2. This is the modulation percentage meter. Adjust the zero set on the meter until the pointer reads on the lower edge of the wide zero line.

2 - Remove the meter short and adjust R15 until the meter pointer reads on the upper edge of the zero line. R15 is located underneath the chassis on the resistor board. This adjustment is locked by means of the hexagon lock nut to assure permanency of this setting.

CAUTION: Allow at least thirty minutes for the tubes to reach normal operating temperature before completing step two.

This is a critical adjustment and for that reason it is advisable to double check this step since tube V4 may be biased beyond cut-off or conductance. For proper operation tube V4 should draw a slight amount of current -- enough to move the meter pointer from the lower edge of the zero mark to the upper edge.

3 - Adjust R1 for 100% modulation as outlined under the "Adjustment" section.

4 - Recheck steps two and three.

GUARANTEE

For guarantee see back page of this book entitled "Guarantee".

GATES SERVICE

GATES SERVICE IS NATION-WIDE AND MORE THAN A SLOGAN. OVER 5000 ITEMS CARRIED IN STOCK AND WE ENJOY SERVING YOUR EVERY NEED, SMALL OR LARGE. THE NEXT TIME YOU NEED QUICK ACTION - TRY GATES. SIX DAILY AIR FLIGHTS AND FOUR DAILY BURLINGTON STREAMLINERS SPEED YOUR AIR OR RAIL EXPRESS TO YOU.

<u>Symbol No.</u>	<u>Drawing No.</u>	<u>Description</u>
A1		Neon Lamp 1 W. with double Auto Base G.E. Vapor Co. "NE32, T10"
A2		Neon Lamp 1 W. with double Auto Base G.E. Vapor Co. "NE32, T10"
A3		Fuseholder #1075 Littlefuse #341001 LITTELFUSE
C1		10 mmfd., 500V. Mica Condenser 5W5Q1 C-D
C2		140 mmfd., Variable Condenser MC-140-S Hammarlund
C3		15 mmfd., Padding Condenser LC-2076 Bud
C4		240 mmfd., 500 V. Mica Condenser K-1324 Sangamo
C5		240 mmfd., 500 V. Mica Condenser K-1324 Sangamo
C6		.25 mfd., 400 V. Tubular Condenser DT-4P25 C-D
C7		.25 mfd., 400 V. Tubular Condenser DT-4P25 C-D
C8		.0068 mfd., 500 V. Mica Condenser C-06268 Sangamo
C9		.05 mfd., 400 V. Tubular Condenser DT-4S5 C-D
C10		.01 mfd., 400 V. Tubular Condenser DT-4S1 C-D
C11		.05 mfd., 400 V. Tubular Condenser DT-4S5 C-D
C12		25 mfd., 25 V. Tubular Condenser BR-252-A C-D
C13		10-10 mfd., 450 V. Dual Condenser UP-1145 C-D
C14		Part of C13
E1		Relay Type 2091 Advance Relay Co. Coil Voltage 115 V. 60 Cy. "with armature stop made of 16 Ga. CRS
F1		Fuse 3 amp. 3 AG Littlefuse LITTELFUSE
L1		R.F. Choke #4537 Miller
L2		R.F. Choke #4537 Miller
L3		Choke #4542 Miller
L4		Choke R18 U.T.C.
M1	A-2071-1	Meter 0-5 MA Model 301 Weston with scale drawn to A-2071
M2	A-1363-2	Modulation Meter Special Weston with scale drawn to A-2027
R1	A-3404-20	5000 ohm Control Purchased from Centralab
R2		680,000 ohm $\frac{1}{2}$ W. Resistor 10% Type EB Allen Bradley
R3		68,000 ohm 1 W. Resistor 10% Type GB Allen Bradley
R4		10,000 ohm 1 W. Resistor 10% Type GB Allen Bradley
R5	A-3404-19	5000 ohm control Purchased from Centralab IRC
R6	A-3404-11	25,000 ohm Control Purchased from Centralab
R7		33,000 ohm 2 W. Resistor 10% Type HB Allen Bradley

R8		10,000 ohm 1 W. Resistor 10% Type GB Allen Bradley
R9		680,000 ohm 1 W. Resistor 10% Type GB Allen Bradley
R10		680,000 ohm 1 W. Resistor 10% Type GB Allen Bradley
R11		3 ohm 25 W. Variable Tap Resistor #0361 Ohmite
R12		20 Megohm, 1 W. 5% Type GB Allen Bradley
R13		12,000 ohm 1 W. Resistor 5% Type GB Allen Bradley
R14		110,000 ohm 1 W. Resistor 5% Type GB Allen Bradley
R15		50,000 ohm 2 W. Control #CU5031 Ohmite
R16		470,000 ohm $\frac{1}{2}$ W. Resistor 10% Type EB Allen Bradley
R17		2400 ohm 1 W. Resistor 5% Type GB Allen Bradley
R18		82,000 ohm 1 W. Resistor 5% Type GB Allen Bradley
R19	A-3404-1	250,000 ohm Control Purchased from Centralab
R20		150,000 ohm 1 W. Resistor 10% Type GB Allen Bradley
R21		350 ohm 10W. Wirewound Resistor Lectrohm
R22		12,000 ohm 1 W. Resistor 5% Type GB Allen Bradley
R23		24,000 ohm 1 W. Resistor 5% Type GB Allen Bradley
R24		1000 ohm 1 W. Resistor 10% Type GB Allen Bradley
R25		82,000 ohm 2 W. Resistor 10% Type HB Allen Bradley
R26		2500 ohm 25 W. Adjustable resistor #0378 Ohmite
R27		4700 ohm 1 W. Resistor 10% Type GB Allen Bradley
R28		82,000 ohm 2 W. Resistor 10% Type HB Allen Bradley
S1		Rotary Switch, 3 Circuit, 3 position, 2 Section #1323-L Mallory
S2		Rotary Switch, D.P.S.T. SW-1073 Bud
T1	C-15316-1	Power Transformer Special Air Design
T2	AO-3047	Output Transformer, Triad Transformer Mfg. Co.
TB1		10-142-Y Jones Terminal Board
V1		Type 6X5 Tube
V2		Type 6C5 Tube
V3		Type 6X5 Tube
V4		Type 6C5 Tube
V5		Type 6C5 Tube
V6		Type 6F6 Tube
V7		Type 885 Tube
V8		Type 6X5 Tube
V9		Type VR-150 Tube
X1		Socket #9956 Cinch <i>MIP-8T AMPHENOL</i>
X2		Same as X1
X3		Same as X1
X4		Same as X1
X5		Same as X1
X6		Same as X1
X7		Socket MIP-57Amphenol
X8		Same as X1
X9		Same as X1

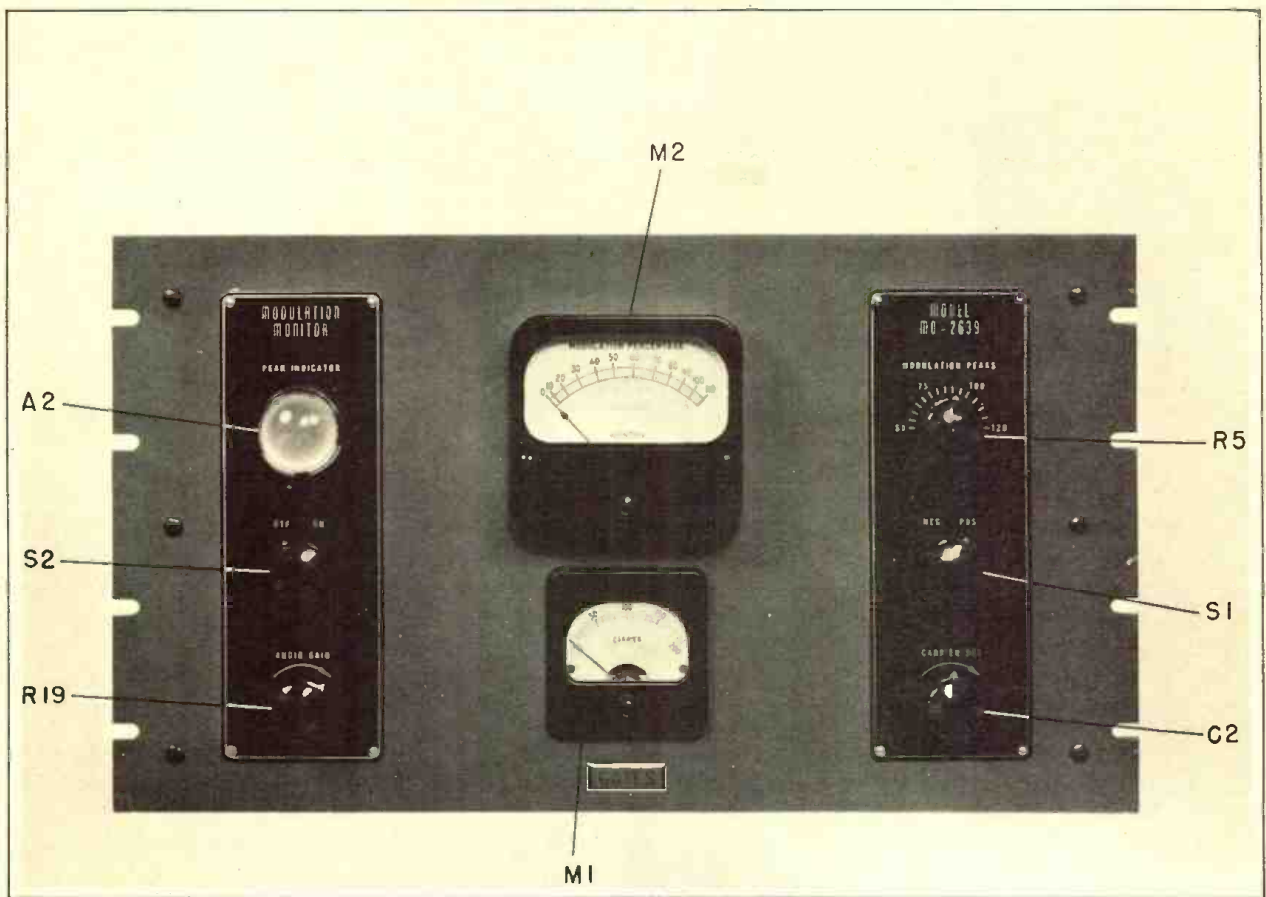

Fig. A - Front MO2639 Modulation Monitor

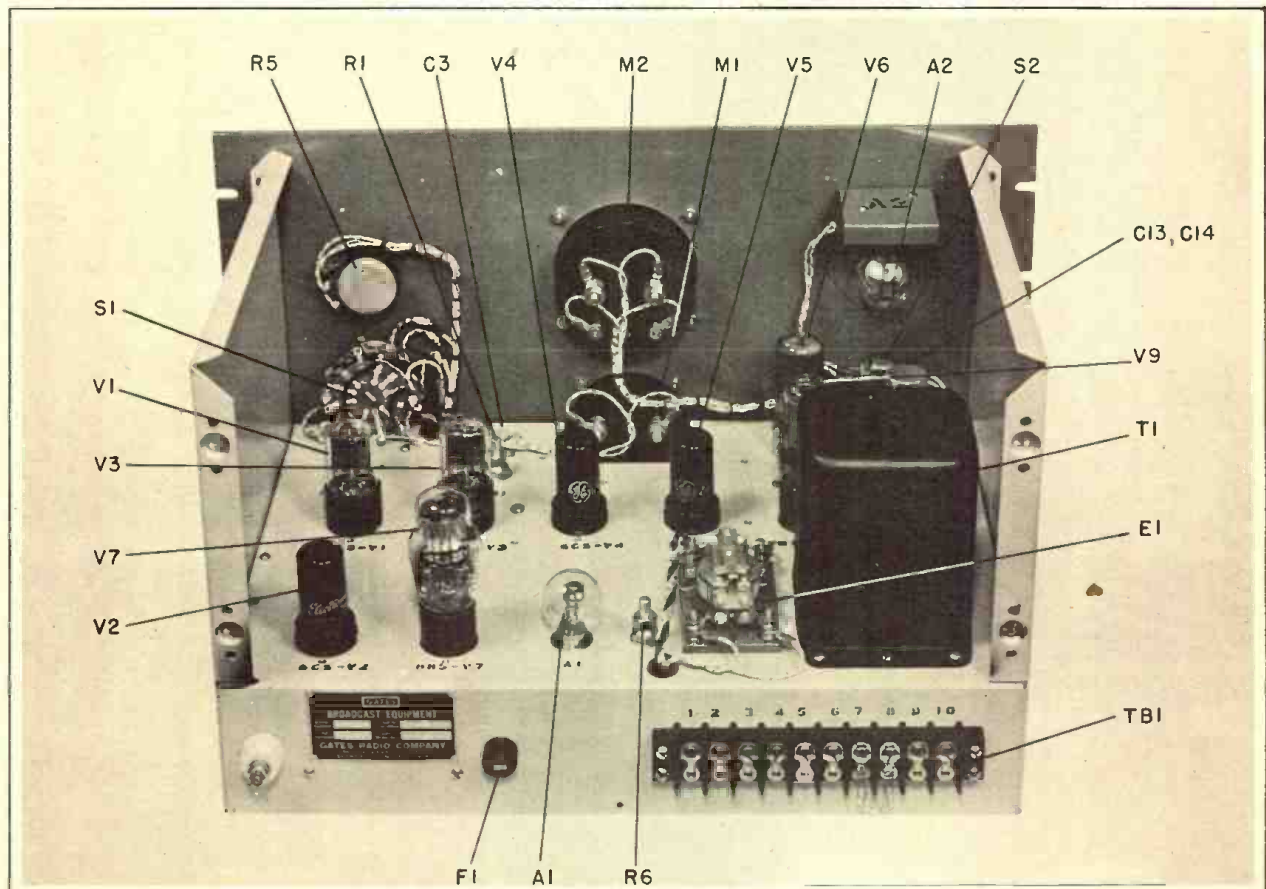

Fig. B - Rear MO2639 Modulation Monitor

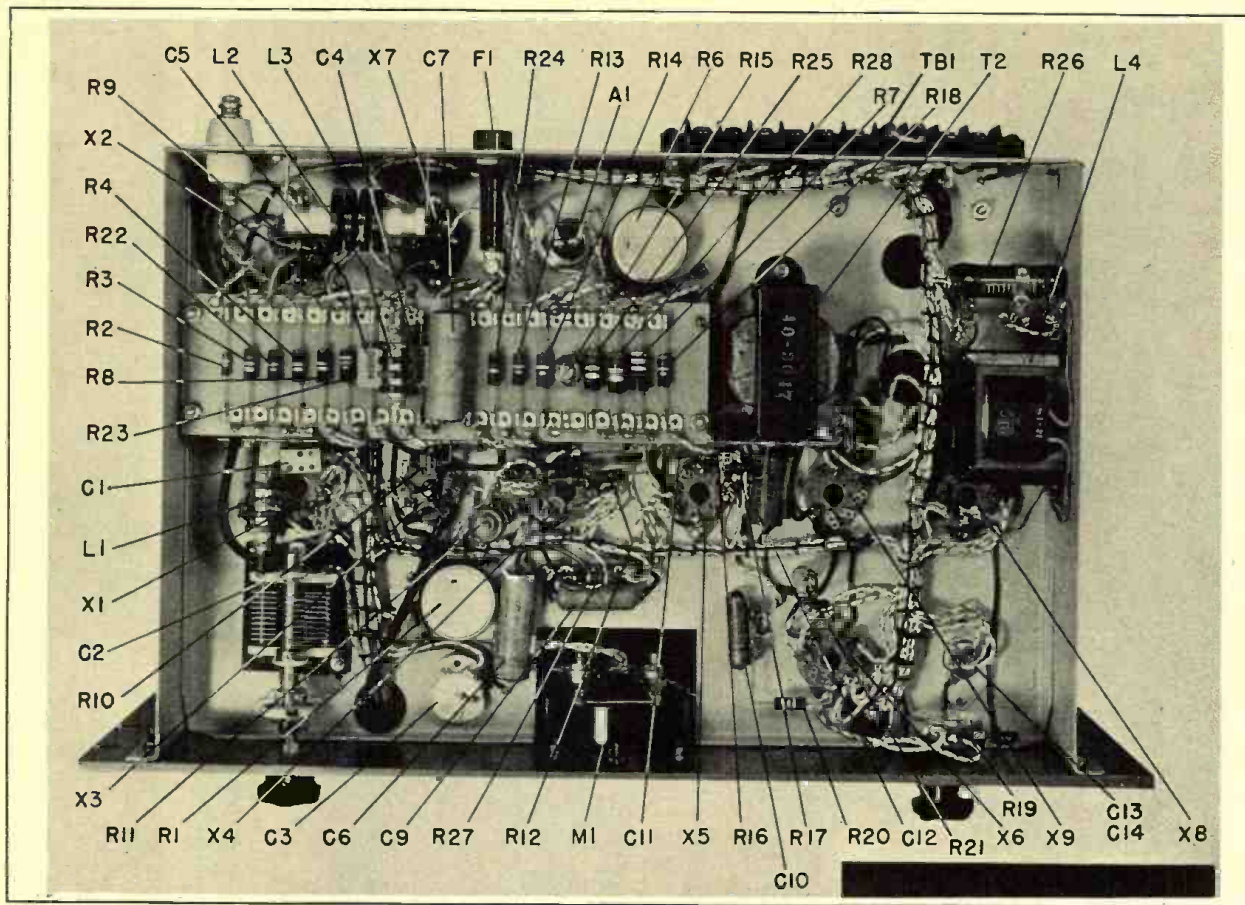
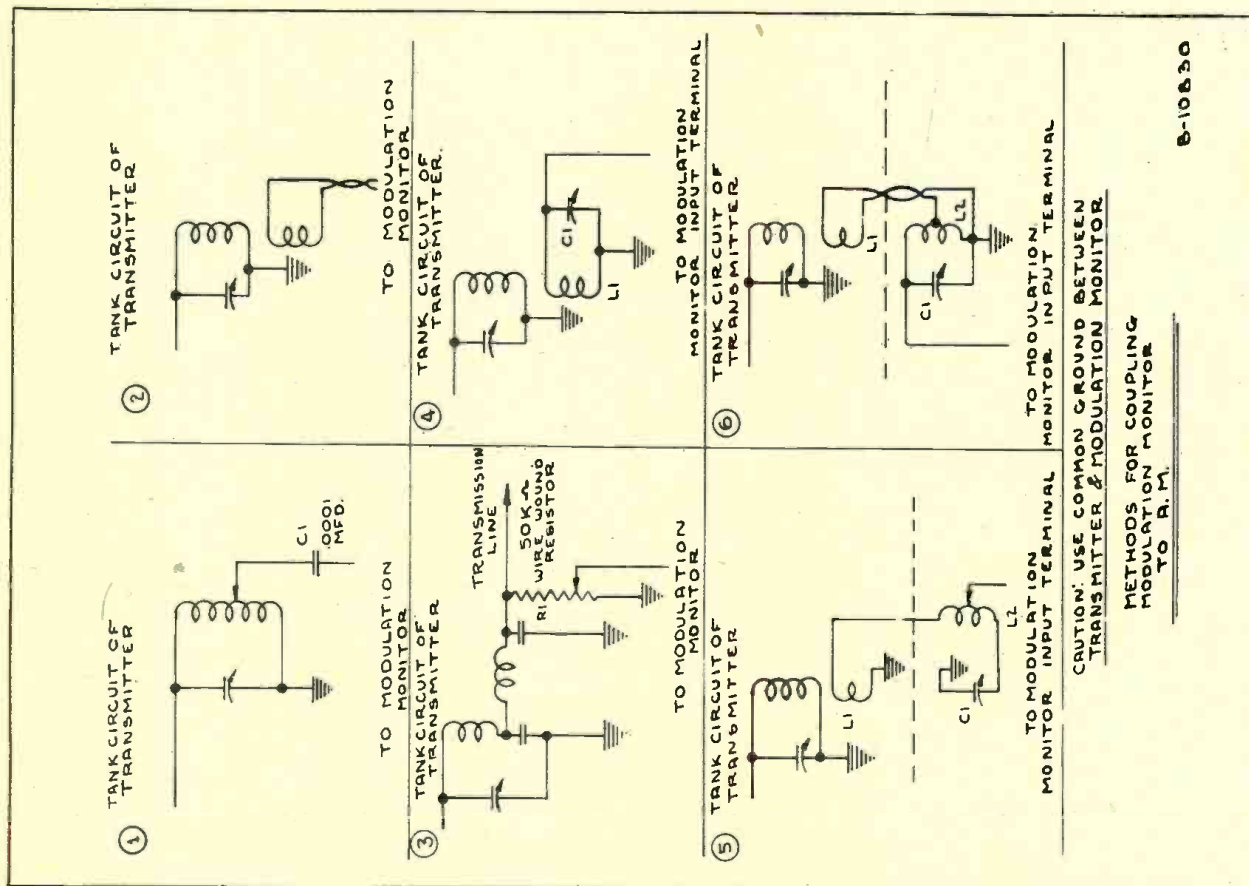
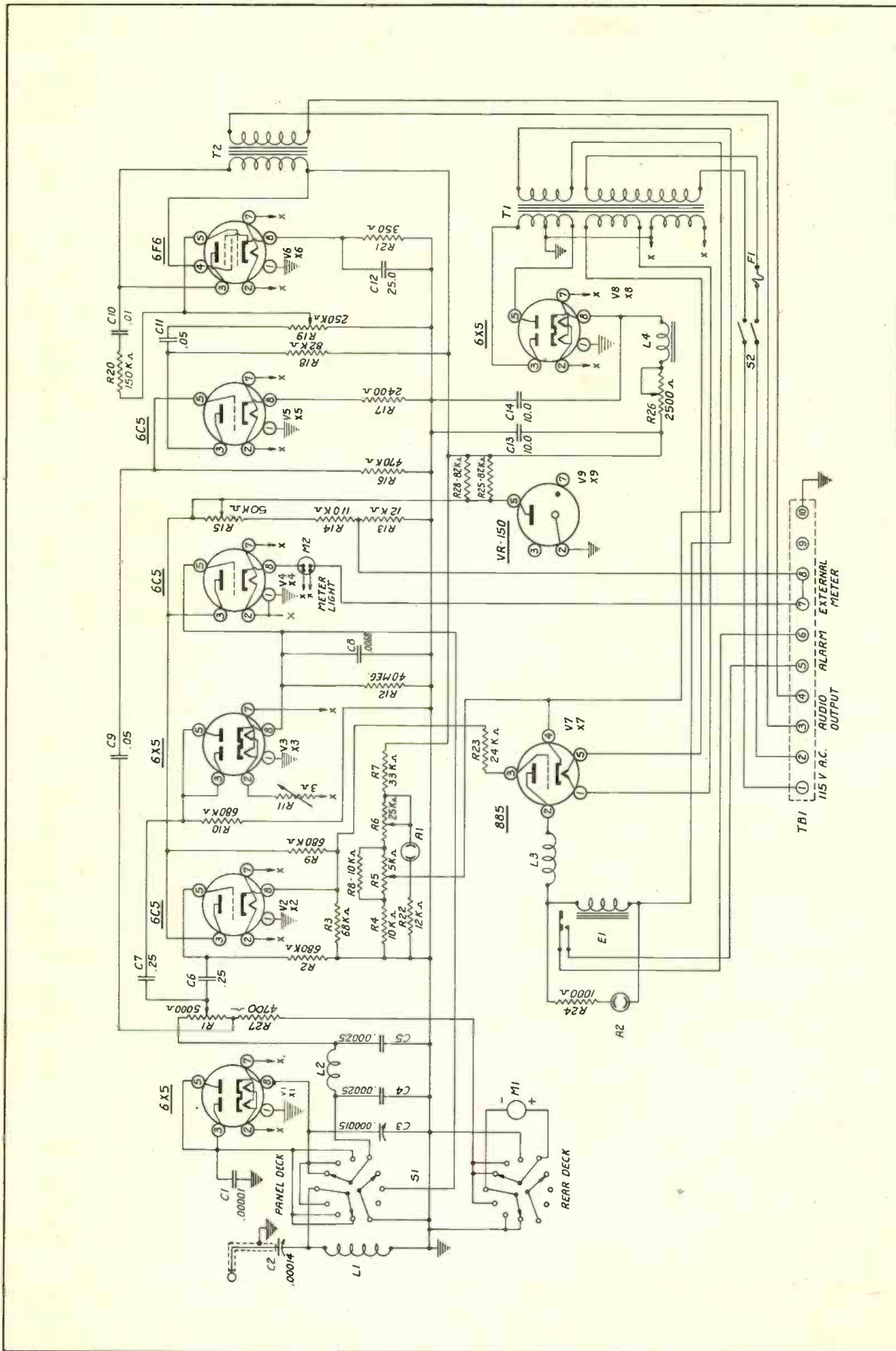

Fig. 6 - Under Chassis MO2639 Modulation Monitor



Coupling Methods



1	REARMAN	1-23-47
2	ECN 751	10-23-47
3	ECN 818	10-23-47
4	ECN 816	10-23-47
5	1-26-50-ALM	
6	1-26-50-ALM	
7	ECN 1211	

CHANGED PER
 ECN 1211
 1-26-50-ALM
 1-26-50-ALM
 ECN 816
 10-23-47
 ECN 818
 10-23-47
 ECN 751
 1-23-47
 REARMAN
 11-5-46 MAY

DR. BY H.A.Y. DATE 11-5-46
 CH. BY G.S.P. ENG. B.E.P. C-15274

DWG. NO.
 C-15274

GATES RADIO CO.
 QUINCY, ILL.

MODULATION MONITOR
 SCHEMATIC MO 2639

GUARANTEE

This equipment is fully guaranteed by the Gates Radio Company of Quincy, Illinois, to be free from all defects in materials and workmanship and will be repaired, replaced or adjusted in accordance with the manufacturer's option and terms as outlined below.

- 1 - Gates believes the purchaser has every right to expect first-class quality materials and workmanship and has created rigid inspection and test procedures plus excellent packing methods to assure good arrival at destination.
- 2 - Gates agrees to supply daily factory service, and will make emergency shipments at any time where possible.
- 3 - Gates fully guarantees, under normal and proper usage, all component parts in Gates equipment, except as noted. These parts will be replaced or repaired at the option of Gates as follows:

Transmitter Parts: main power or plate transformer, modulation transformer, modulation reactor, main tank condensers.

(replacements or repairs) - where less than 1 year old ... no charge
Between 1 and 2 years old ... 50% of new price

Moving Parts: Guaranteed for six months.

Electron Tubes: Subject to manufacturer's warranty at the time of shipment. Adjustment will be made to the customer as given to Gates Radio Company by the tube manufacturer.

All other component parts: (except as listed above or below)
Guaranteed for one year.

Abuse: Damage resulting from an Act of God, or by fire, wind, rain, hail, or any other condition other than normal usage is not covered by the guarantee.

- 4 - Date of invoice to original user-purchaser and date of receipt by Gates Radio Company of notification from the customer will determine the age of equipment or parts.
- 5 - In case of adjustment, as on certain transmitter parts listed above, "new price" is Gates' current price at time of replacement and/or adjustment.
- 6 - This guarantee covers only Gates manufactured parts and complete Gates equipments including all parts therein, with exceptions as noted. Any purchased part not manufactured by Gates will be subject to the manufacturer's guarantee, unless such part is a unit incorporated in Gates manufactured equipment.

- 7 - Transcription pickups, regardless of make, are guaranteed for ninety days - said guarantee including every associated part of the pickup except the stylus, which because of its fragility is not guaranteed by Gates.
- 8 - Where the replacement part in question must be supplied under the guarantee before the defective part can be returned for inspection, as might sometimes be required, the customer will be billed in full and credit or adjustment will be given on receipt of the defective part in accordance with this guarantee and the terms herein. In order for credit adjustment to be received in line with this guarantee the defective or replaced part must be shipped prepaid to Gates Radio Company or to any other destination requested by Gates within two weeks of the date of the invoice covering the replacement part. Any item alleged defective shall not be returned to Gates until after written permission has been first obtained from Gates' home office at your request.
- 9 - All shipments under this guarantee will be made f.o.b. Quincy, Illinois and all materials returned will be shipped prepaid by the customer f.o.b. Quincy, Illinois.
- 10 - As a material part of this guarantee the customer agrees to employ capable technical personnel to maintain all equipment under this guarantee in good, normal condition, properly serviced and cleaned, and to use said equipment as and for the purpose intended by seller. This guarantee does not extend to the supply by Gates of any personnel to make any replacement, repair or adjustment.
- 11 - Gates shall not be responsible for damages to items in transportation or careless handling; or injuries to persons or damage to property arising out of the use or operation of Gates equipment or parts, but Gates will supply repair or replacement items speedily, which will be billed to the customer who, in turn, will place claim with the carrier, with assistance from Gates if necessary and when so requested.
- 12 - Delays in fulfilling any part of this guarantee because of depleted stock, floods, war, strikes, power failures, transportation delays, or failure of suppliers to deliver, or because of Acts of God or any other conditions beyond the control of Gates, does not in any way render Gates liable under this guarantee; however, every effort will be made to render prompt service.
- 13 - Gates agrees that this equipment sold is manufactured, where need be, under Royalty License Agreements with Western Electric Company and Radio Corporation of America.
- 14 - This Guarantee is not transferable from the original user-purchaser, and no right of subrogation is given herein.
- 15 - This Guarantee is effective on all standard Gates cataloged items sold after June 11, 1951.

GATES RADIO COMPANY
Quincy, Illinois

DATA SHEET

This sheet to be used by radio station for operating data applicable to local conditions such as gain settings, meter readings, etc. Also to be used for addendas or corrections if any error discovered either by customer or Gates subsequent to publication.

